

# Specification

## CUN6GF1A(CA3535)

## [ Contents ]

- 1. Description**
- 2. Outline dimensions**
- 3. Characteristics of CUN6GF1A**
- 4. Characteristic diagrams**
- 5. Binning & Labeling**
- 6. Reel packing**
- 7. Recommended solder pad**
- 8. Reflow Soldering profile**
- 9. Reliability**
- 10. Precaution for use**
- 11. Revision history**

# CUN6GF1A(CA3535)

## Description

High power UV LED series are designed for high current operation and high power output applications.

It incorporates state of the art SMD design and low thermal resistant material.

CUN6GF1A(CA3535) NUV LED is ideal UV light source for curing, printing, and detecting applications.

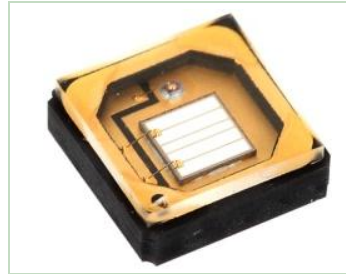

## CUN6GF1A

### Features

- Super high power output
- Designed for high current operation
- Low thermal resistance
- SMT solderable
- Lead Free product
- RoHS compliant

### Applications

- UV Curing
- Printing
- Coating
- Adhesive
- Counterfeit Detection/ Security
- UV Torch
- Fluorescence Photography
- Dental Curing
- Crime Inspection
- Oil leak Detection

## Outline dimensions

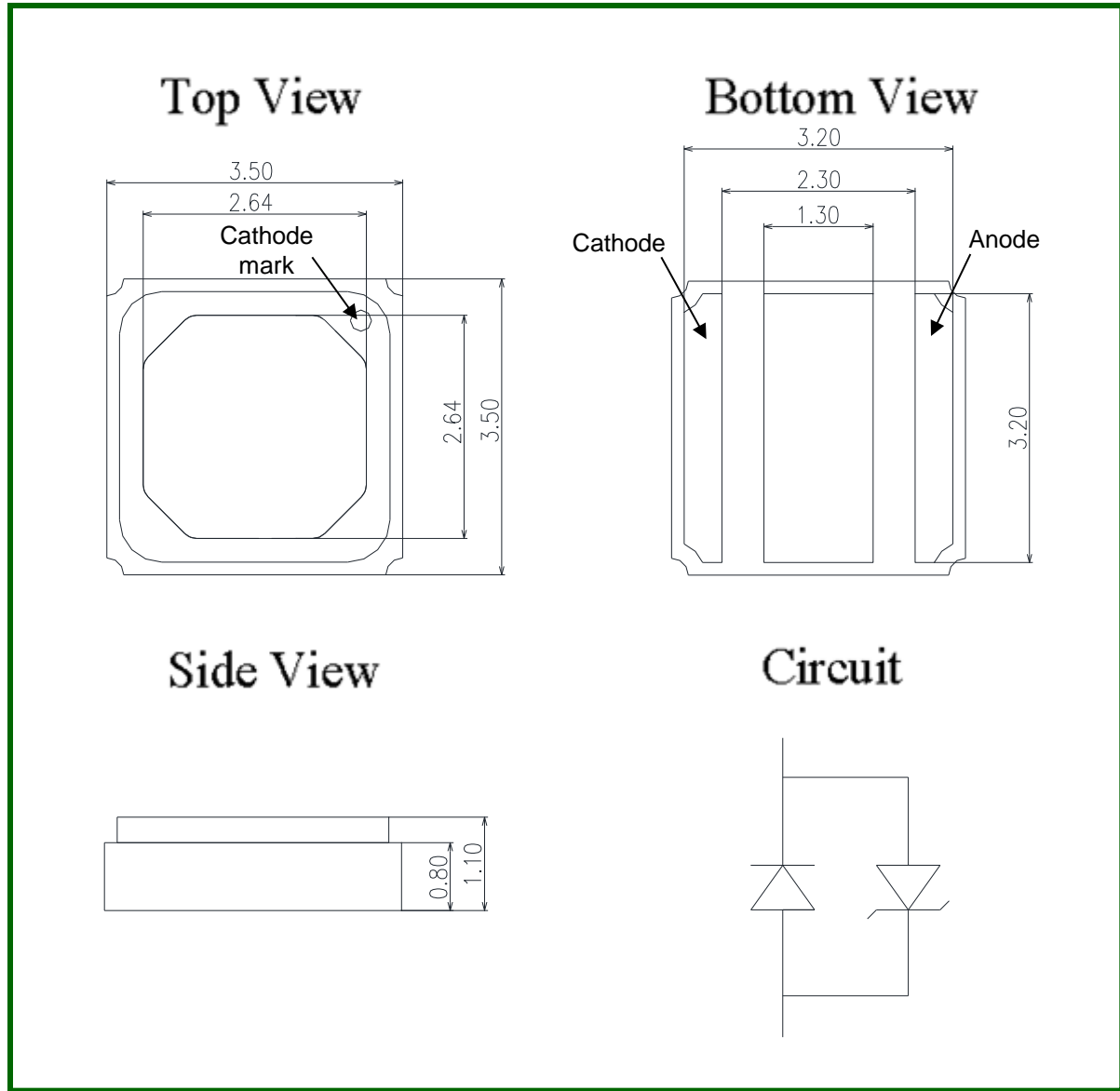

Notes :

- [1] All dimensions are in millimeters.
- [2] Scale : none
- [3] Undefined tolerance is  $\pm 0.2\text{mm}$

# Characteristics of CUN6GF1A

## 1 Electro-Optical characteristics at 1000mA

( $T_a=25^{\circ}\text{C}$ , RH=30%)

Parameter	Symbol	Value	Unit
Peak wavelength [1]	$\lambda_p$	365	nm
Radiant Flux[2]	$\Phi_e$ [3]	1150	mW
Forward Voltage [4]	$V_F$	3.7	V
Spectrum Half Width	$\Delta \lambda$	10	nm
View Angle	$2\theta_{1/2}$	115	deg.
Thermal Resistance	$R_{\theta_{j-b}}$	7.1	$^{\circ}\text{C}/\text{W}$

## 2 Absolute Maximum Ratings

Parameter	Symbol	Value	Unit
Forward Current	$I_F$	1400	mA
Junction Temperature	$T_j$	125	$^{\circ}\text{C}$
Operating Temperature	$T_{opr}$	-10 ~ +85	$^{\circ}\text{C}$
Storage Temperature	$T_{stg}$	-40 ~ +100	$^{\circ}\text{C}$

Notes :

1. Peak Wavelength Measurement tolerance :  $\pm 3\text{nm}$
2. Radiant Flux Measurement tolerance :  $\pm 10\%$
3.  $\Phi_e$  is the Total Radiant Flux as measured with an integrated sphere.
4. Forward Voltage Measurement tolerance :  $\pm 3\%$
5.  $R_{\theta_{j-b}}$  is the thermal resistance between chip junction to PCB board bottom.  
The PCB is made of aluminium and the size of PCB is 2.5cm by 2.5cm

# Characteristic Diagrams

## 1. Relative Spectral Power Distribution

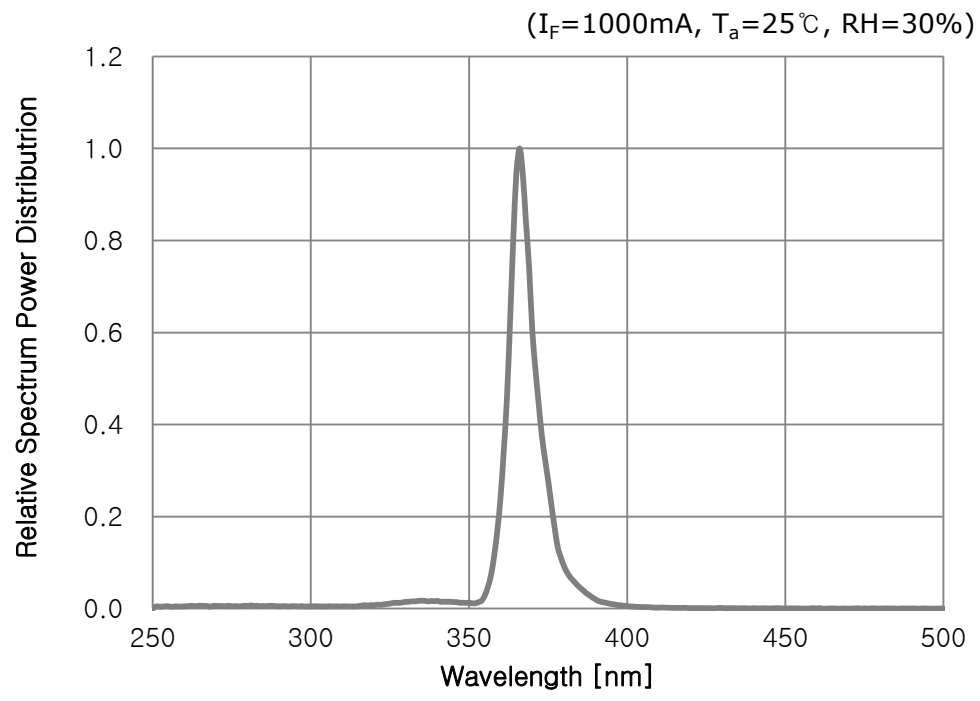

## 2. Forward Current VS Forward Voltage

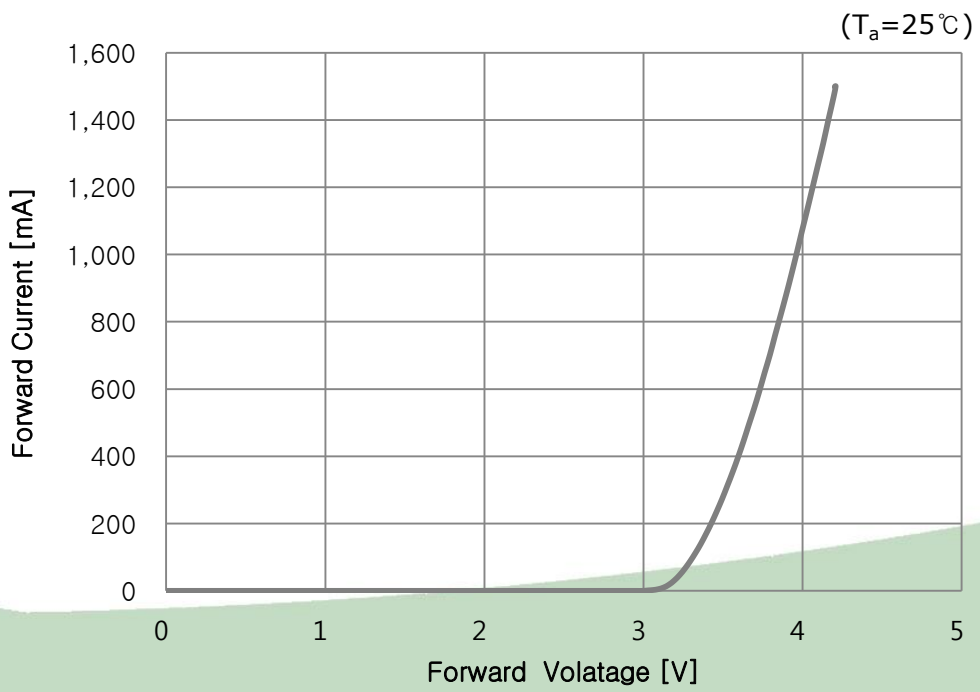

### 3. Relative Radiant Flux VS Forward Current

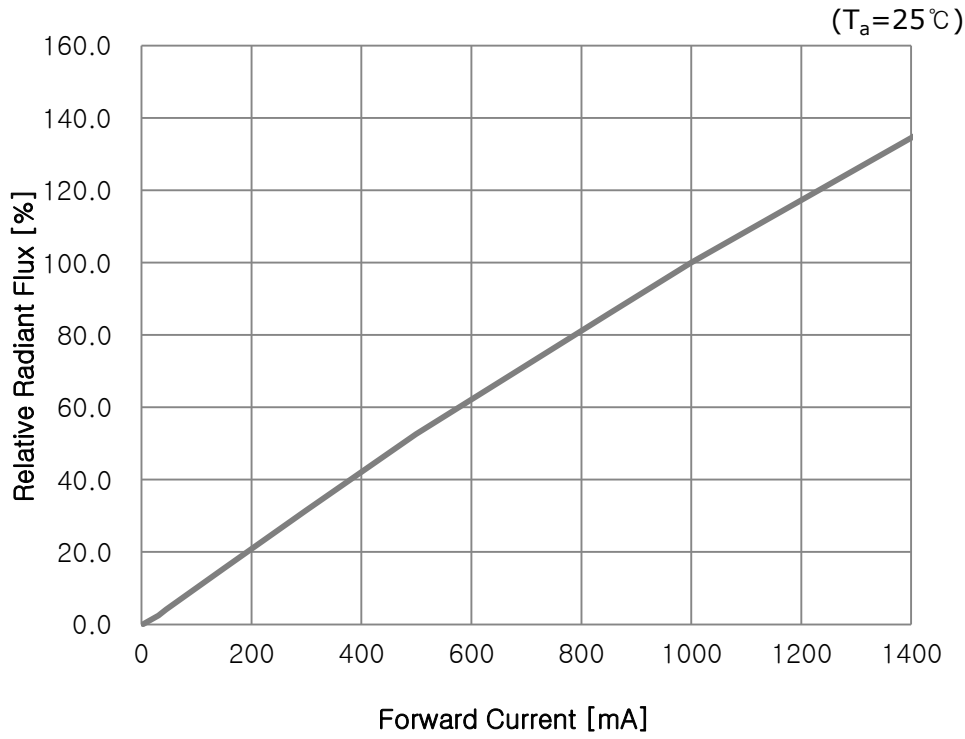

### 4. Peak Wavelength VS Forward Current

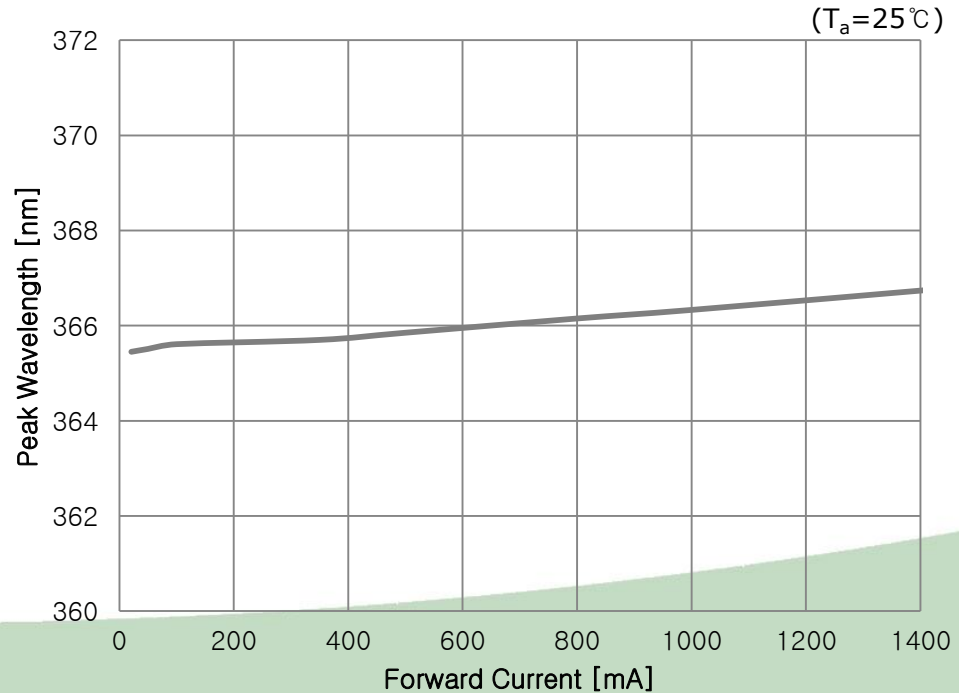

### 5. Relative Radiant Flux VS Ambient Temperature

( $I_f=1000\text{mA}$ )

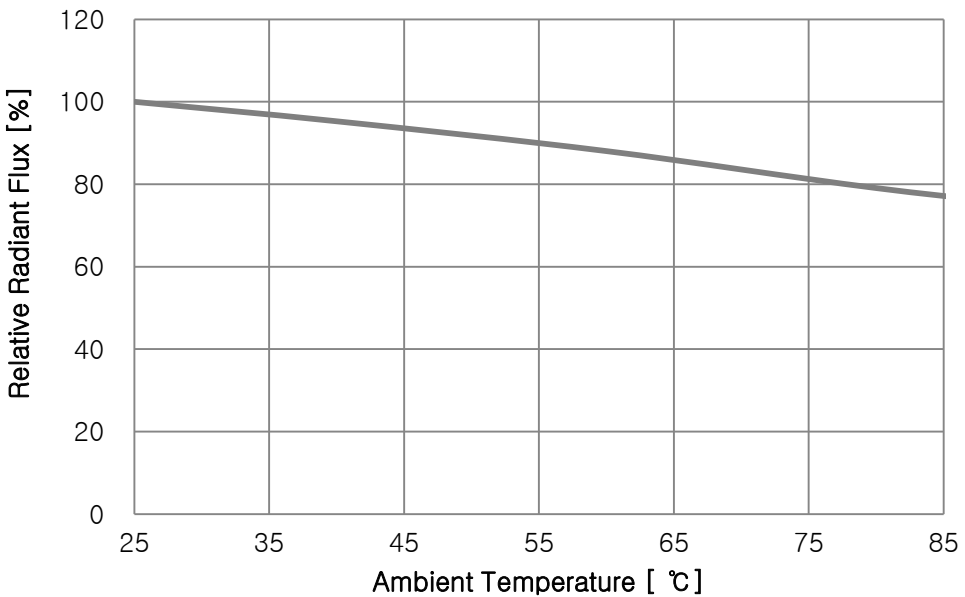

### 6. Peak Wavelength VS Ambient Temperature

( $I_f=1000\text{mA}$ )

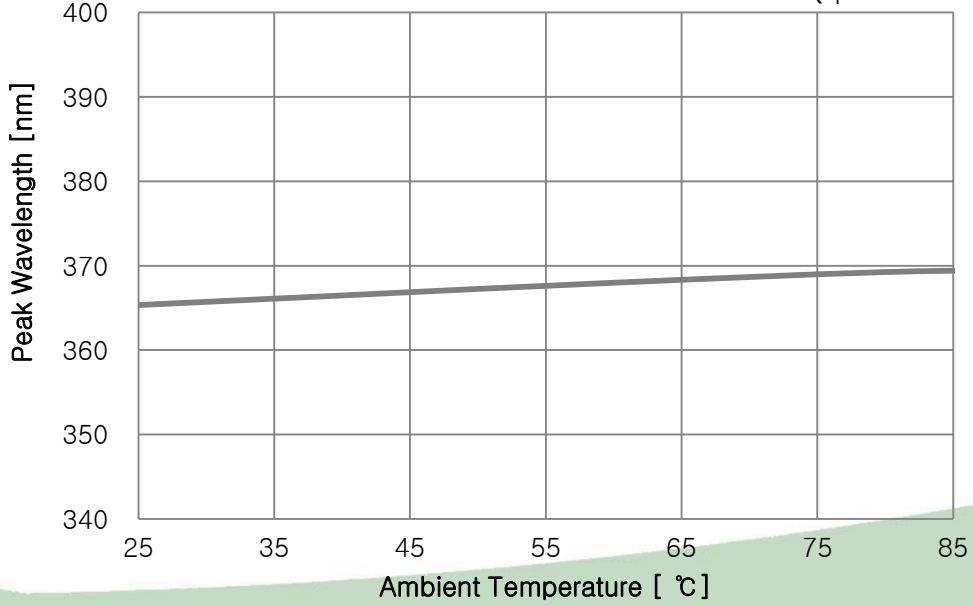



### 7. Forward Voltage VS Ambient Temperature

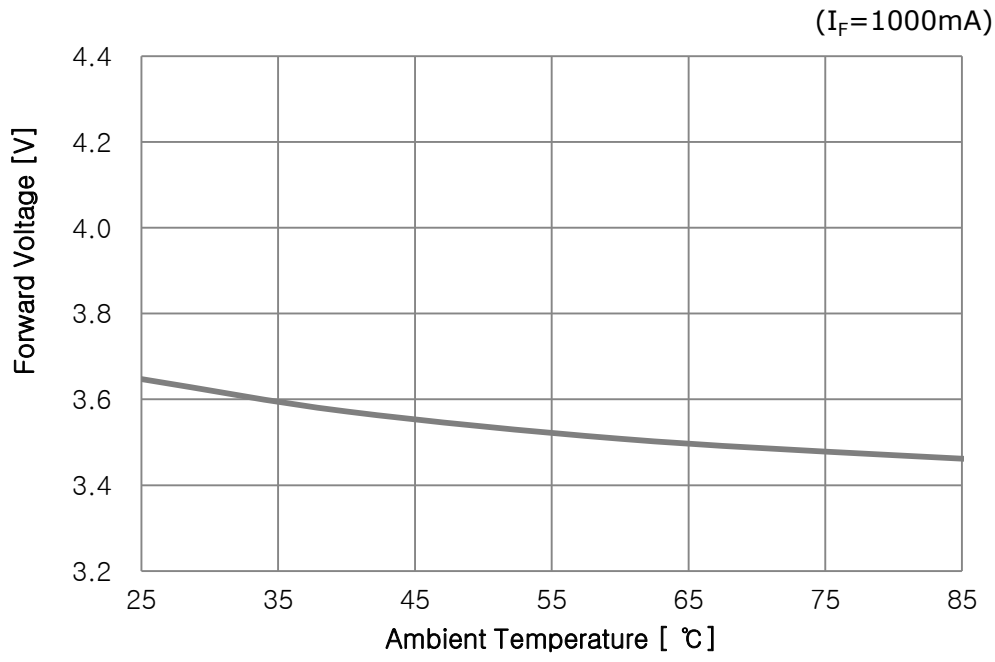

### 8. Radiation pattern

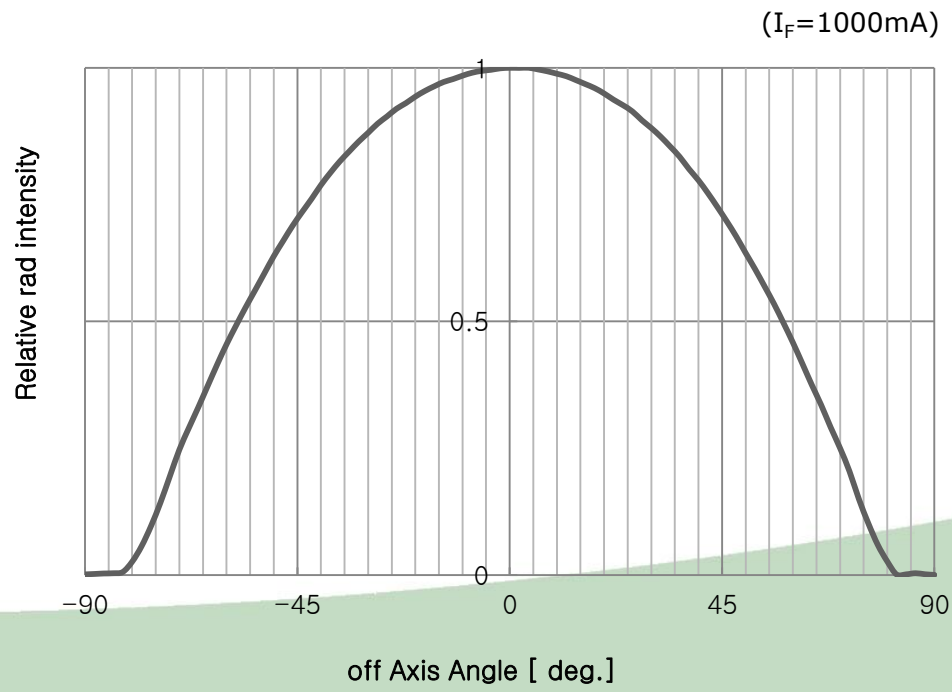

### 9. Allowable Forward Current VS Ambient Temperature

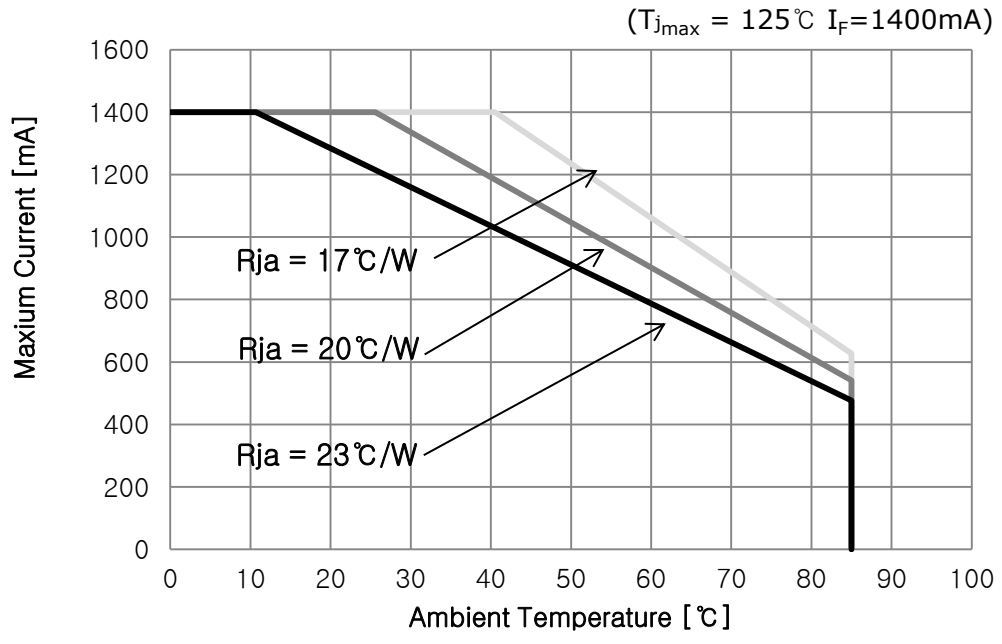

# Binning & Labeling

## 1. Binning Structure

$$\underline{Y_1 Y_2 Y_3 Y_4 Y_5 Y_6}$$

( $I_f=1000\text{mA}$ )

Y <sub>1</sub>			Y <sub>2</sub> Y <sub>3</sub> Y <sub>4</sub>			Y <sub>5</sub> Y <sub>6</sub>		
Wp [nm]			Radiant Flux [mW]			Vf [V]		
BIN	MIN	MAX	BIN	MIN	MAX	BIN	MIN	MAX
j	360	370	<b>B00</b>	960	1000	<b>Z6</b>	3.5	3.6
			<b>B04</b>	1000	1040	<b>Z7</b>	3.6	3.7
			<b>B08</b>	1040	1080	<b>Z8</b>	3.7	3.8
			<b>B12</b>	1080	1120	<b>Z9</b>	3.8	3.9
			<b>B16</b>	1120	1160			
			<b>B20</b>	1160	1200			
			<b>B25</b>	1200	1250			
			<b>B30</b>	1250	1300			

## 2. Rank

- **Y<sub>1</sub> : Peak Wavelength [nm]**
- **Y<sub>2</sub>Y<sub>3</sub>Y<sub>4</sub> : Radiant Flux [mW]**
- **Y<sub>5</sub>Y<sub>6</sub> : Forward Voltage [V]**

Notes :

1. Peak Wavelength Measurement tolerance :  $\pm 3\text{nm}$
2. Radiant Flux Measurement tolerance :  $\pm 10\%$
3. Forward Voltage Measurement tolerance :  $\pm 3\%$

**3. Label**

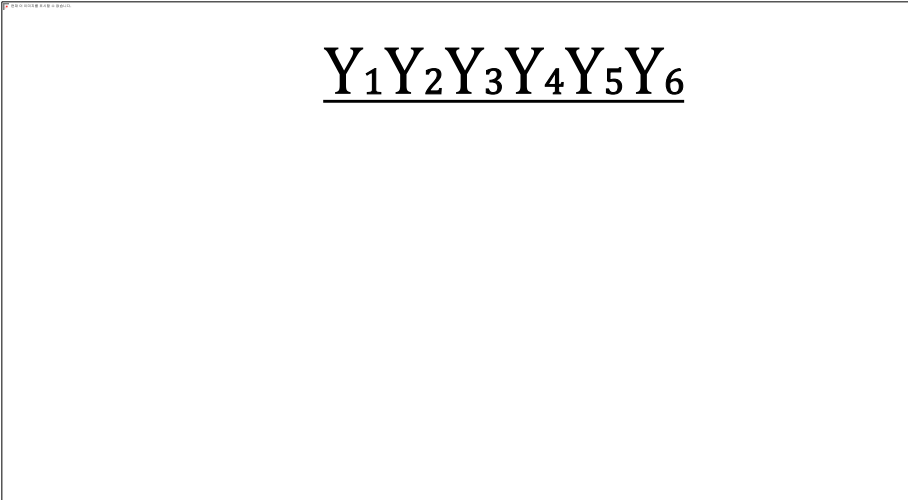

**4. SVC PART NUMBER : X1X2X3X4X5X6X7X8**

X <sub>1</sub>		X <sub>2</sub>		X <sub>3</sub> X <sub>4</sub>		X <sub>5</sub>		X <sub>6</sub>		X <sub>7</sub>		X <sub>8</sub>	
Company		Product Line		Wavelength		PKG Series		Lens Type		Chip Q'ty		Ver	
SVC	C	UV	U	Near 365	N6	CA3535	G	Flat	F	1	1	ver0	A

# Reel Packaging

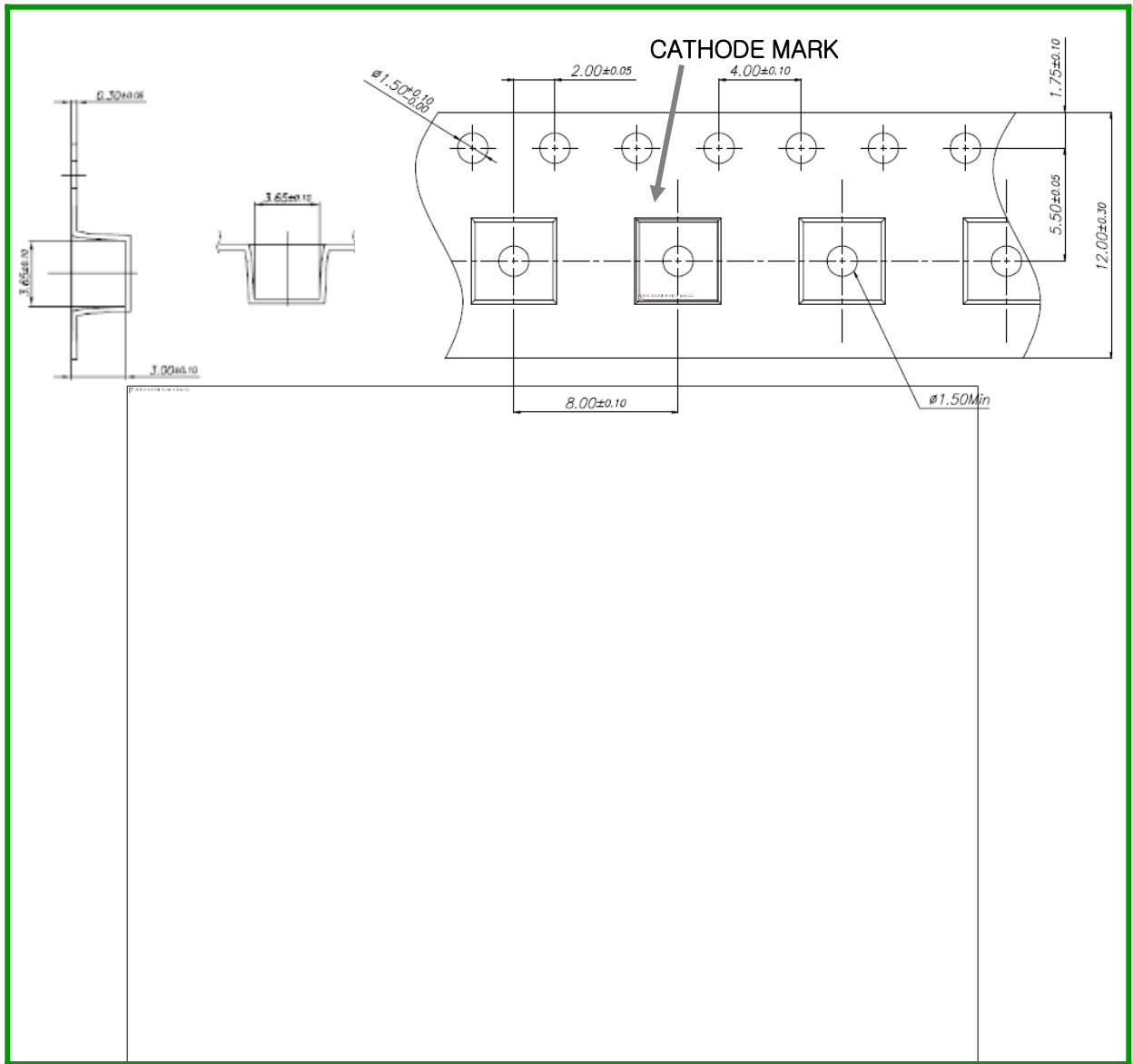

## Recommended solder pad

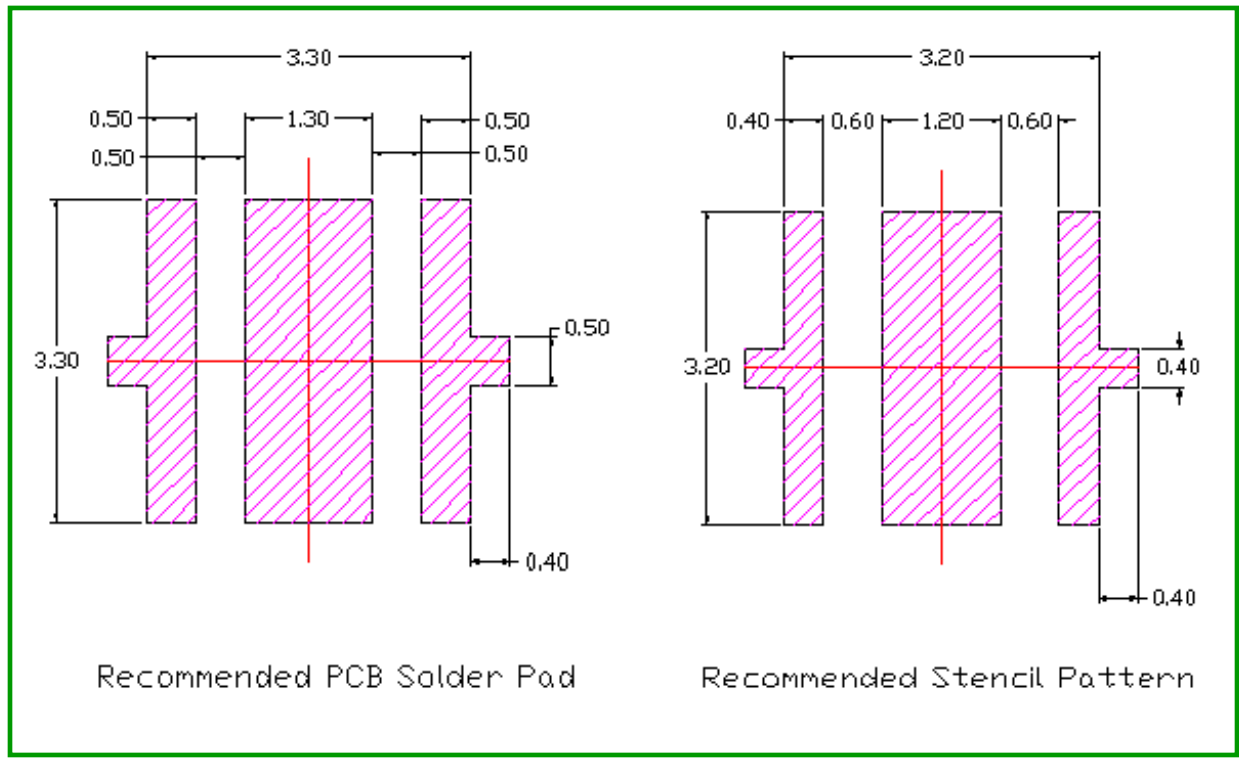

Recommended PCB Solder Pad

Recommended Stencil Pattern

Notes :

- [1] All dimensions are in millimeters.
- [2] Scale : none
- [3] This drawing without tolerances is for reference only

## Reflow Soldering Profile

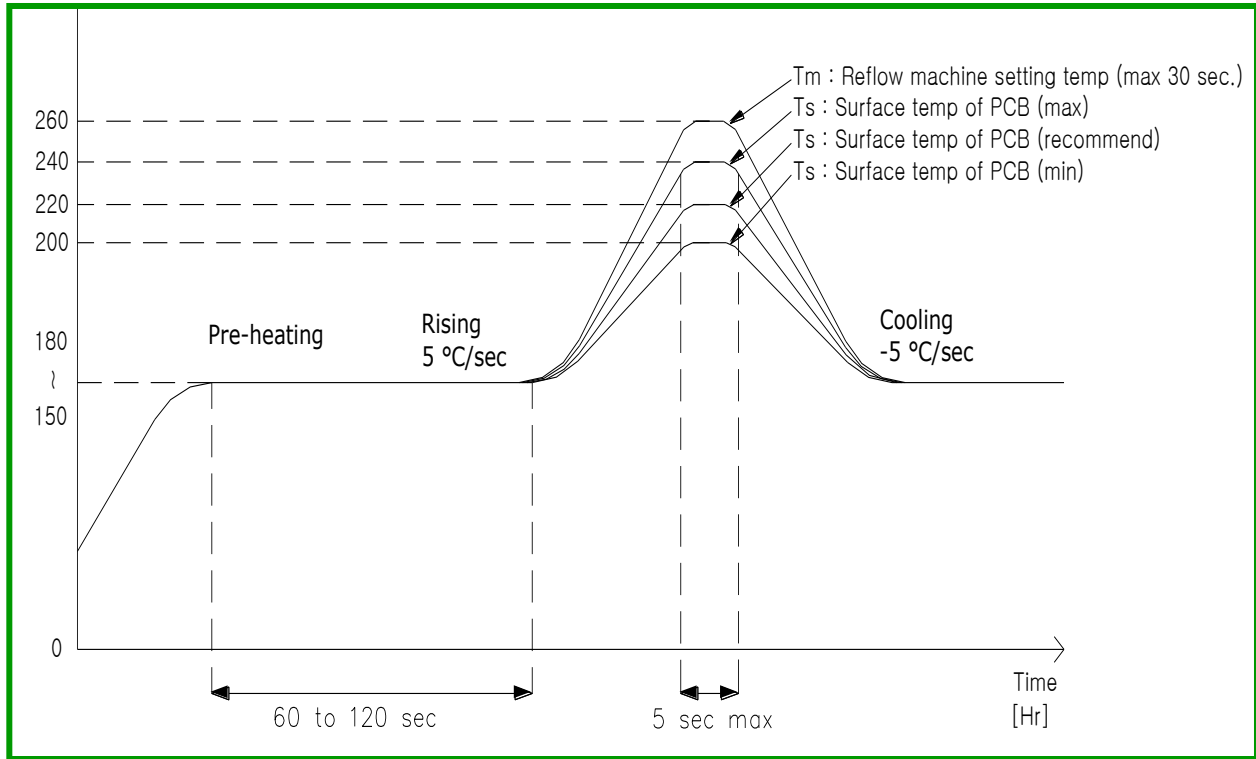

### \* Caution

1. Reflow soldering should not be done more than one time.
2. Repairs should not be done after the LEDs have been soldered. When repair is unavoidable, suitable tools must be used.
3. Die slug is to be soldered.
4. When soldering, do not put stress on the LEDs during heating.
5. After soldering, do not warp the circuit board.
6. Recommend to use a convection type reflow machine with 7 ~ 8 zones.

# Reliability

## 1. Relative Spectral Power Distribution

Test Item	Test Condition	Note	# Failed /Tested
High Temp. Operational Life	Ta=85°C, IF=1000mA	1000hrs	0/10
Room Temp. Operational Life	Ta=25°C, IF=1000mA	1000hrs	0/10
Thermal shock	Ta max=120°C, Ta min=-40°C 30min dwell/transfer time : 10sec, 1 cycle=1hr	200 cycles	0/22
Resistance to Soldering	Temp=260±5°C, Time : 10±1 sec	1 time	0/10
Solderability	Temp=260±5°C, 95% Coverage	1 time	0/10
ESD	R=1.5kΩ, C=100pF Voltage level=2kV	3 times Negative /positive	0/22

## 2. Failure Criteria

Parameter	Symbol	Test Conditions	Max. or Min. allowable shift value
Forward Voltage	V <sub>F</sub>	IF=1000mA	Max. Initial measurement x 1.2
Radiant Flux	Φ <sub>e</sub>	IF=1000mA	Min. Initial measurement x 0.7

Notes :

1. The value is measured after the test sample is cooled down to the room temperature.



## Precaution for use

### 1) Storage



- To avoid moisture penetration, we recommend storing UV LEDs in a dry box with a desiccant. The recommended temperature and Relative humidity are between 5°C and 30°C and below 50% respectively.
- LEDs must be stored properly to maintain the device. If the LEDs are stored for 3 months or more after being shipped from SVC, a sealed container with a nitrogen atmosphere should be used for storage.
- Replace the remained LEDs into the moisture-proof bag and reseal the bag after work to avoid those LEDs being exposed to moisture. Prolonged exposure to moisture can adversely affect the proper functioning of the LEDs.
- If the package has been opened more than 168hr(MSL\_3) or the color of the desiccant changes, components should be dried for 10-12hr at 60±5°C
- The conditions of resealing are as follows
  - Temperature is 5 to 40°C and Relative humidity is less than 30%

### 2) Handling Precautions

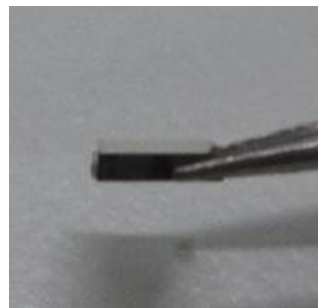
- VOCs (Volatile organic compounds) emitted from materials used in the construction of fixtures can penetrate silicone encapsulants of LEDs and discolor them when exposed to heat and photonic energy. The result can be a significant loss of light output from the fixture. Knowledge of the properties of the materials selected to be used in the construction of fixtures can help prevent these issues.
- In case of attaching LEDs, do not use adhesives that outgas organic vapor.
- Soldering should be done as soon as possible after opening the moisture-proof bag.
- Do not rapidly cool device after soldering.
- Do not apply mechanical force or excess vibration during the cooling process to normal temperature after soldering.
- Components should not be mounted on warped (non coplanar) portion of PCB.
- The UV LED is encapsulated with a glass lens for the highest flux efficiency. So it needs to be handled carefully as below
  - Avoid touching glass lens parts especially with sharp tools such as pincettes(Tweezers)



- Avoid leaving fingerprints on glass lens parts.
  - When populating boards in SMT production, there are basically no restrictions regarding the form of the pick and place nozzle, except that excessive mechanical pressure on the surface of the resin must be prevented.
- 3) Safety for eyes and skin
- The Products emit high intensity ultraviolet light which can make your eyes and skin harmful, So do not look directly into the UV light and wear protective equipment during operation.
- 4) Cleaning
- This device is not allowed to be used in any type of fluid such as water, oil, organic solvent , etc.
- 5) Others
- The appearance and specifications of the product may be modified for improvement without notice.
  - When the LEDs are in operation the maximum current should be decided after measuring the package temperature.
  - The driving circuit must be designed to allow forward voltage only when it is ON or OFF. If the reverse voltage is applied to LED, migration can be generated resulting in LED damage.
  - Do not handle this product with acid or sulfur material in sealed space.

	 <b>CAUTION</b>
	<ul style="list-style-type: none"> <li>•UV LEDs emit high intensity UV light.</li> <li>•Do not look directly into the UV light during operation. This can be harmful to your eyes and skin.</li> <li>•Wear protective eyewear to avoid exposure to UV light.</li> <li>•Attach caution labels to your products which contain UV LEDs.</li> </ul> <p style="text-align: center;"><b>Avoid direct eye and skin exposure to UV light. Keep out of reach of children.</b></p>

### Revision history

REV	Change Date	Brief summary of change
-	May 08, 2015	preliminary specification
00	June 12, 2015	Initial specification